

F-1001M_H

MODULAR FLAKER ICE MACHINE

SLIM-LINE SERIES

Item # _____

Project: _____

Qty: _____

*AutoCad available on KCL

F-1001M_H

4/08

Item # 13108

FLAKER DIMENSIONS

W x D x H

F-1001M_H

22 x 27^{3/8} x 25^{15/16}



B-300

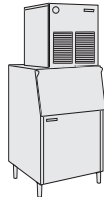

B-500



B-700

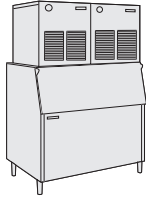

B-800

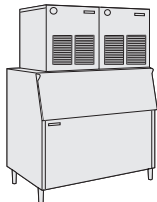

B-900

Also available on Large Bins:

B-1150SS

B-1300SS

B-1500SS

B-1650SS



F-1001MAH

Air-Cooled

Shown on an optional
B-700

F-1001MWH

Water-Cooled

F-1001MRH

Remote Air-Cooled

- Up to 970 lbs. of ice production per 24 hours
- Durable stainless steel exterior
- CleanCycle I2® Design 
- 15 minute flush cycle every 12 hours
- Removes sediment
- Cleaner ice
- Longer life and easy maintenance
- R-404A Refrigerant



Warranty

Valid in United States, Canada, Puerto Rico, & U.S. Territories. Contact factory for warranty in other countries.

Two Year - Parts & Labor on entire machine.

Five Year - Parts on compressor, air-cooled condenser coil.



Hoshizaki

F-100IM_H FLAKER ICE MACHINE SLIM-LINE MODULAR SERIES

DIMENSIONS
W x D x H
F-100IM H
22 x 27^{3/8} x 25^{15/16}

- Air-cooled
- Water-cooled
- Remote Air-cooled

AIR-COOLED

Water Temp ° F.	50°	70°	90°
Air Temp ° F.			
70°	970	930	890
80°	855	820	785
90°	755	740	695

WATER-COOLED

Water Temp ° F.	50°	70°	90°
Air Temp ° F.			
70°	890	855	840
80°	820	805	785
90°	770	755	735

REMOTE AIR-COOLED

Water Temp ° F.	50°	70°	90°
Air Temp ° F.			
70°	930	895	865
80°	835	805	780
90°	750	745	700

UTILITY CONSUMPTION

Model Number	Approximate Electrical		KWH per 100 LBS.		Condenser Water Gal. per 100 lbs.	
	90/70	70/50	90/70	70/50	90/70	70/50
F-1001MAH	1755	1530	5.7	3.8	N/A	N/A
F-1001MWH	1248	1245	4.1	3.1	63	34
F-1001MRH	1520	1570	4.9	4.1	N/A	N/A

SPECIFICATIONS

Model Number	Condenser	Amperage	Min. Circuit Ampacity	Shipping Weight
F-1001MAH	Air-Cooled	8.1	15	210 lbs.
F-1001MWH	Water-Cooled	7.2	15	210 lbs.
F-1001MRH	Remote Air-Cooled	10.2	15	210 lbs.

STORAGE BINS

Model Number	Application Capacity	ARI-Rated Capacity
B-300	300 lbs.	260 lbs.
B-500	500 lbs.	360 lbs.
B-700	700 lbs.	550 lbs.
B-800	800 lbs.	600 lbs.
B-900	900 lbs.	660 lbs.
B-1150	1150 lbs.	N/A
B-1300	1275 lbs.	N/A
B-1500	1490 lbs.	N/A
B-1650	1605 lbs.	N/A

ELECTRICAL & PLUMBING/F-100IM_H

- 208-230V/60/1 (3 wire with dedicated neutral for 115V)
- 1/2" OD copper or equivalent independent potable water supply
- 3/4" FPT independent drain connection



© HOSHIZAKI AMERICA, INC.

618 Hwy. 74 S., Peachtree City, GA 30269



FRONT VIEW

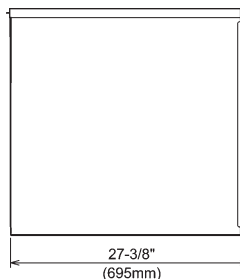

SIDE VIEW

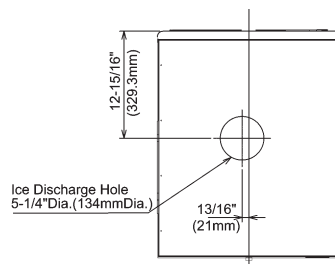

ICE DROP ZONE

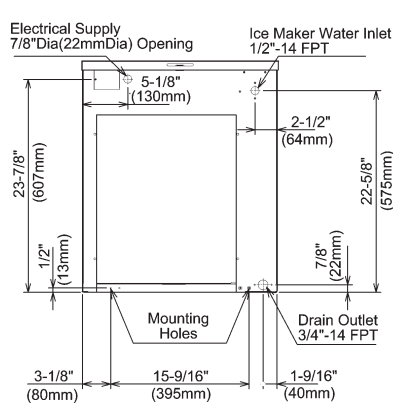

AIR-COOLED UNIT

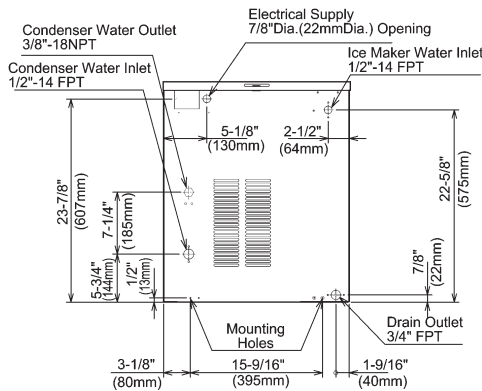

WATER-COOLED UNIT

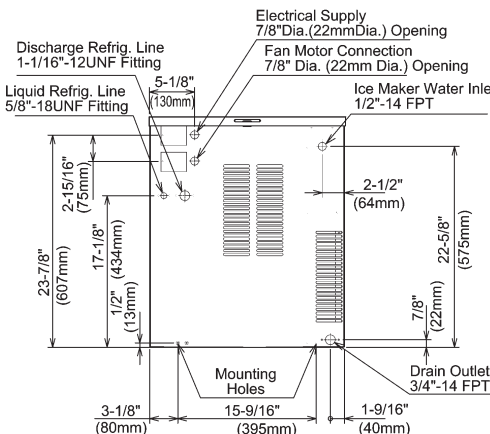

REMOTE AIR-COOLED UNIT

URC-6F Remote Condenser (Sold Separately)
For Use with F-1001MRH

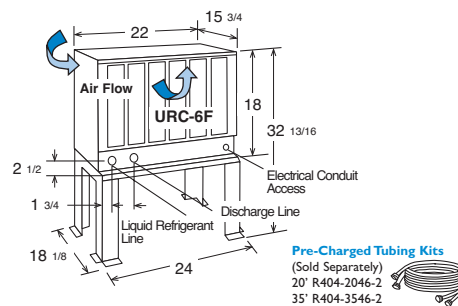

Voltage supply for the URC Remote Condenser is supplied from the Ice Maker. No additional circuit is required.

Pre-Charged Tubing Kits
(Sold Separately)
20' R404-2046-2
35' R404-3546-2

OPERATING LIMITS

- Ambient Temp Range 45 - 100°F
- Water Temp Range 45 - 90°F
- Water Pressure 10 - 113psig
- Voltage Range 187 - 253V

SERVICE

- Panels easily removed and all components accessible for service.
- Removable/cleanable air filter. (Air-Cooled model only)

TEL 1-800-438-6087

FAX 1-800-345-1325

www.hoshizaki.com

Printed in U.S.A.

